

FIND STASH

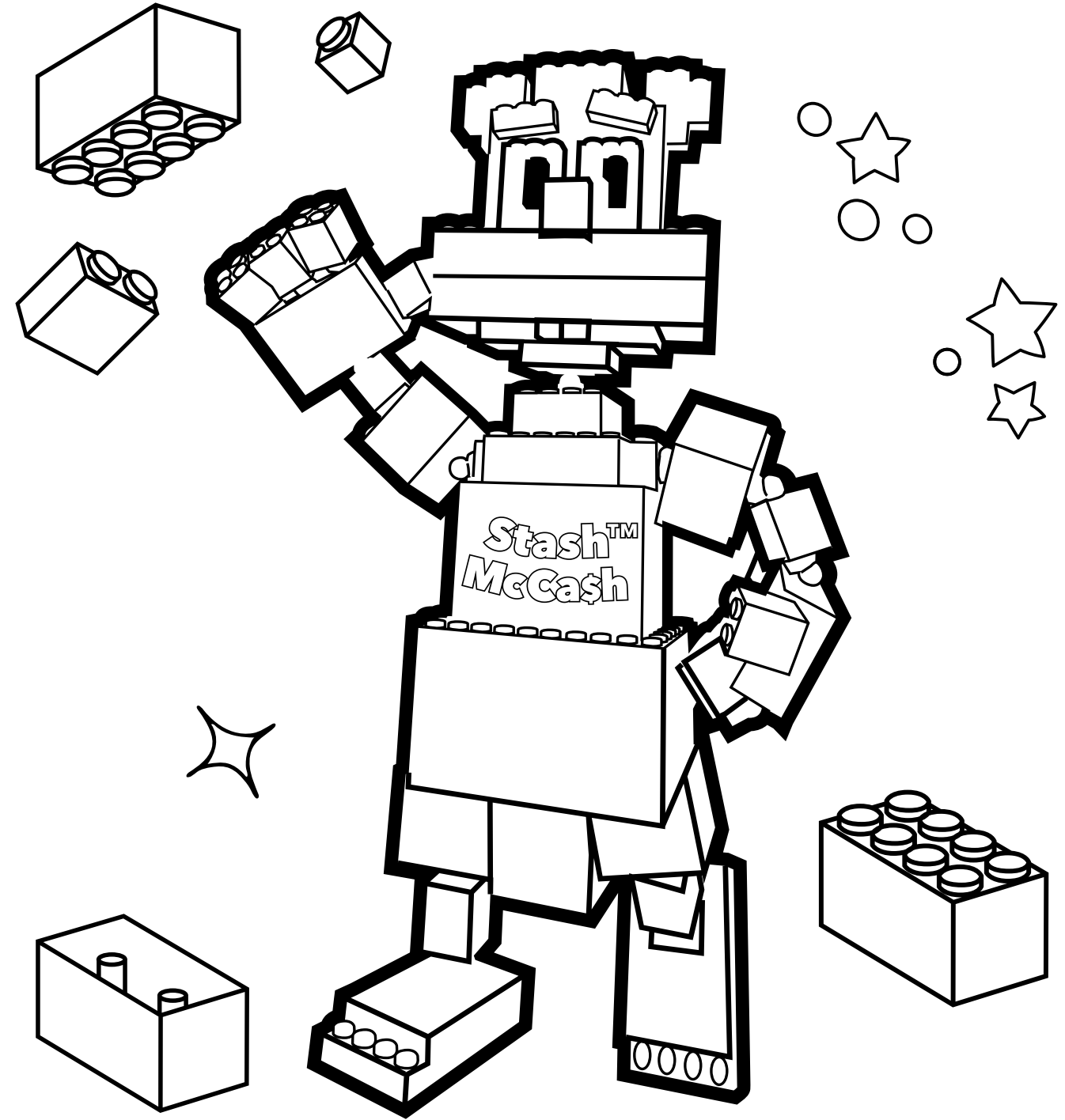

YOUTH ACCOUNTS

ACTIVITY SHEET



Visit ngfcu.us/youth-month

FEDERALLY
INSURED
BY NCUA

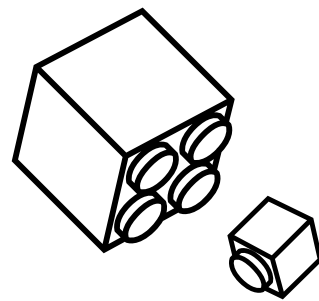

CROSSWORD

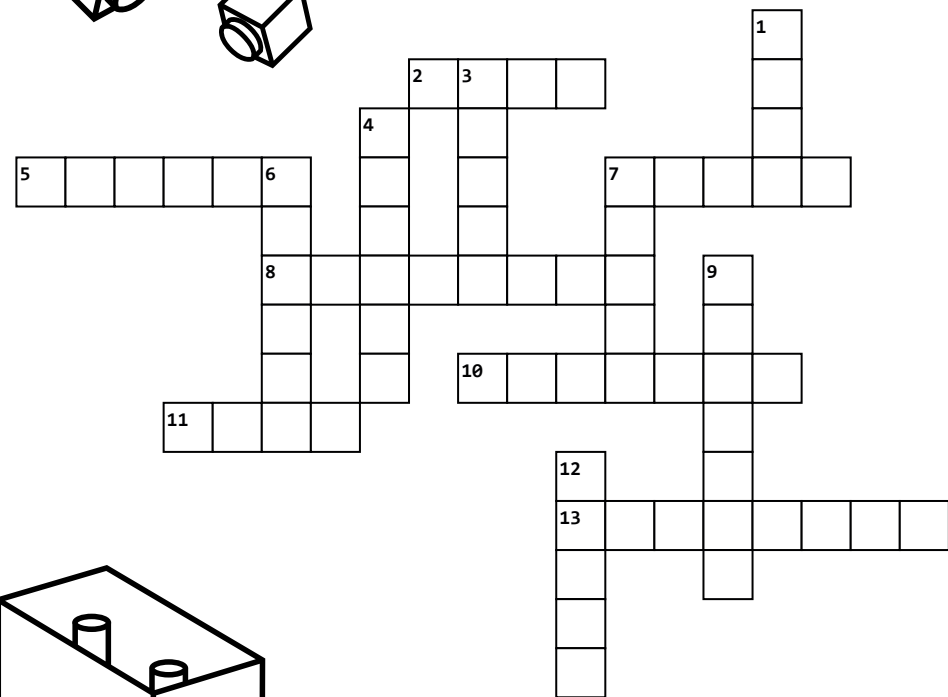

ACROSS

- 2. WARM UP FROM A FREEZE.
- 5. SMALL POOL OF RAIN.
- 7. IT GROWS FOR A SEASON AND REQUIRES WEEKLY TRIMMING.
- 8. IT WARMS AND BRIGHTENS EVERYTHING.
- 10. COLORFUL ARC IN THE SKY CAST BY LIGHT-RAYS HITTING WATER DROPLETS.
- 11. WRIGGLY CREATURE THAT LIVES IN THE GROUND.
- 13. IT HELPS KEEP THE RAIN OFF YOU.

DOWN

- 1. THEY FLY FROM PLANT TO PLANT CARRYING POLLEN.
- 3. COME OUT OF AN EGG.
- 4. MEAL IN THE PARK ON A SUNNY DAY.
- 6. HOLIDAY IN THE SPRING WITH LOTS OF EGGS AND BUNNIES.
- 7. THE COLOR OF SPRING GRASS.
- 9. SHORT PASSING RAINFALLS.
- 12. IT IS SOMETIMES WHITE, ALWAYS FURRY, AND HOPS FROM GARDEN TO GARDEN SEARCHING FOR FOOD.

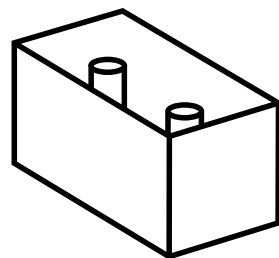

AMAZING MAZE

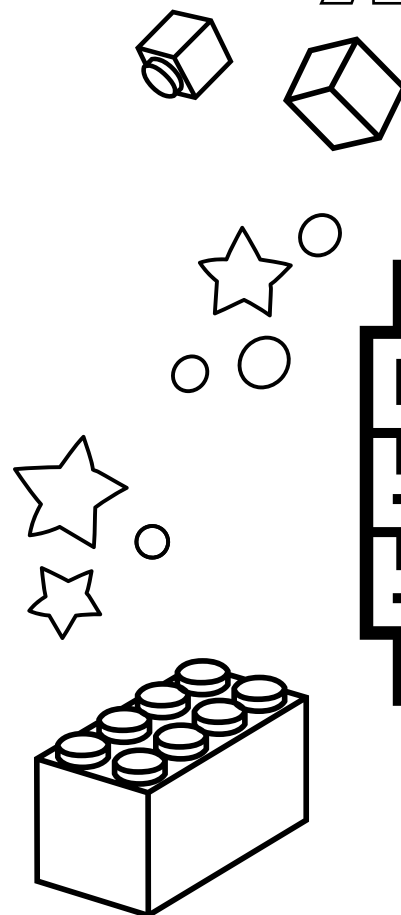
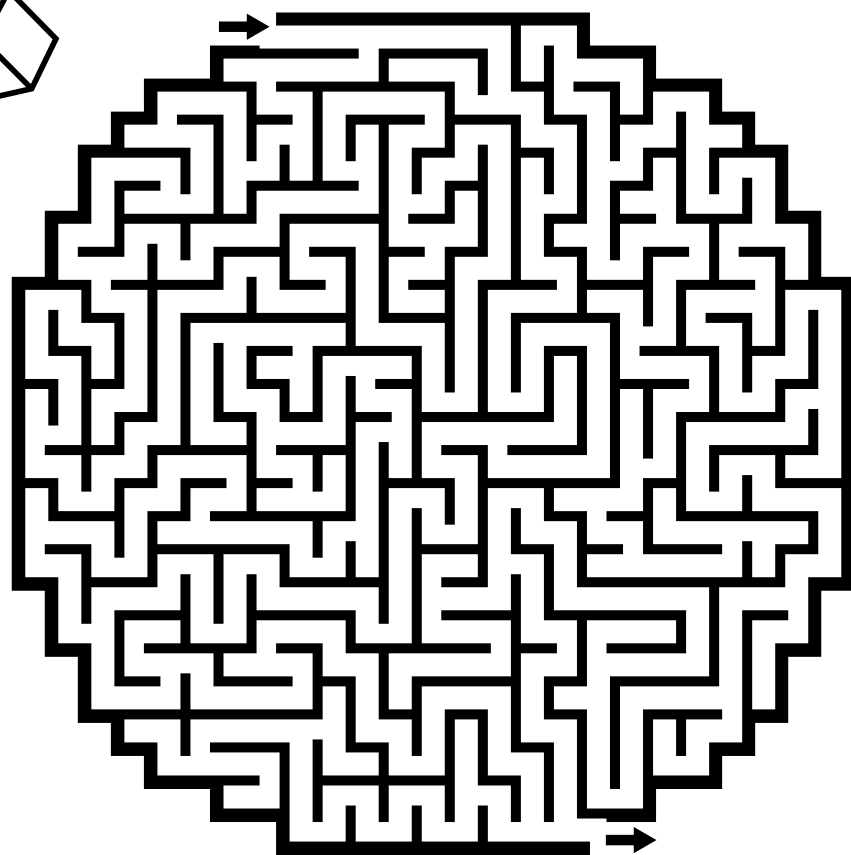

WORD SEARCH

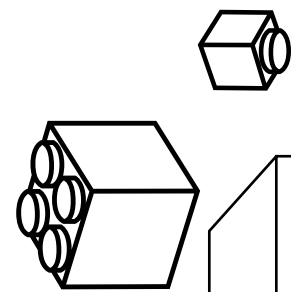

- BUILDING
- SQUIRREL
- FINANCE
- AWESOME
- SAVINGS
- BLOCKS
- MCCASH
- CREDIT
- STASH
- MONEY
- DEBIT
- YOUTH

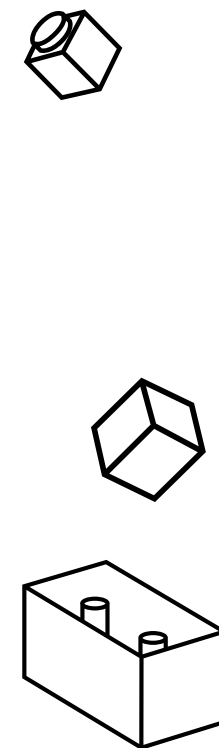

CONNECT THE DOTS

